

Storage Cabinets & Trolleys

Ministore is the ideal storage system for tool rooms, machining centers, inspection area, workstation and tool crib.

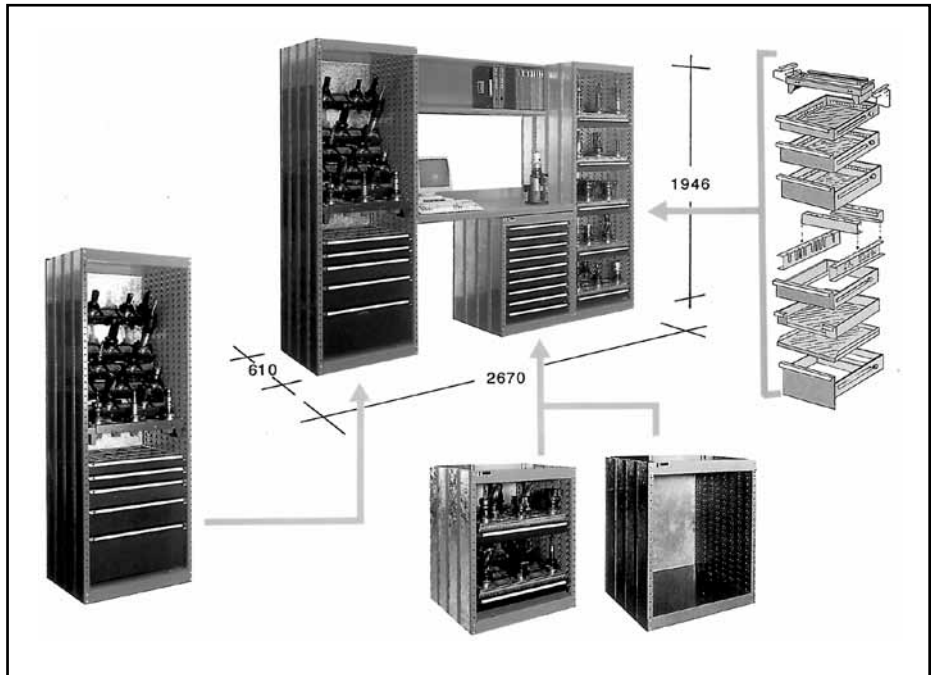

Whether you need to store 100 or 1,000 tools, the Ministore can be adapted to solve your storage problems, to reduce space and increase productivity.

The SUSTA Ministore comprises of 2 SMS 4 Combiracks which are equipped with selected drawers and cradles. A robust work top and overhead document shelf connects the two Combiracks and a half size SMS 675 is placed underneath the worktop in either left or right-hand position.

The Ministore can be expanded as your storage needs grow by simply adding additional shelving modules to both ends.

The 1-3/4" laminated maple work table is available in 24" x 53" and 24" x 79" sizes. It is treated and sealed for long term service in industrial applications. The work table is the ideal location for in-shop computer terminals, gauging devices and presetting fixtures. Plastic-covered and steel work tables are available on request.

The SUSTA Ministore is a system that grows with your needs. Its standard modular drawers and internal components can be installed or moved without the need of any tools and additional Combiracks can be added as needed. The system is completely expandable and interchangeable.

Security

Combiracks can be supplied with lockable doors that open either left or right handed for user convenience and component security.

Document Shelf

Each Ministore is assembled with an upper document shelf which can be divided to accommodate books, files, etc.

Storage Cabinets & Trolleys

Ministore is the system that grows with your needs. Standard modular drawers can be added without need of nuts or bolts and additional Combracks added as needed providing complete inter-changeability

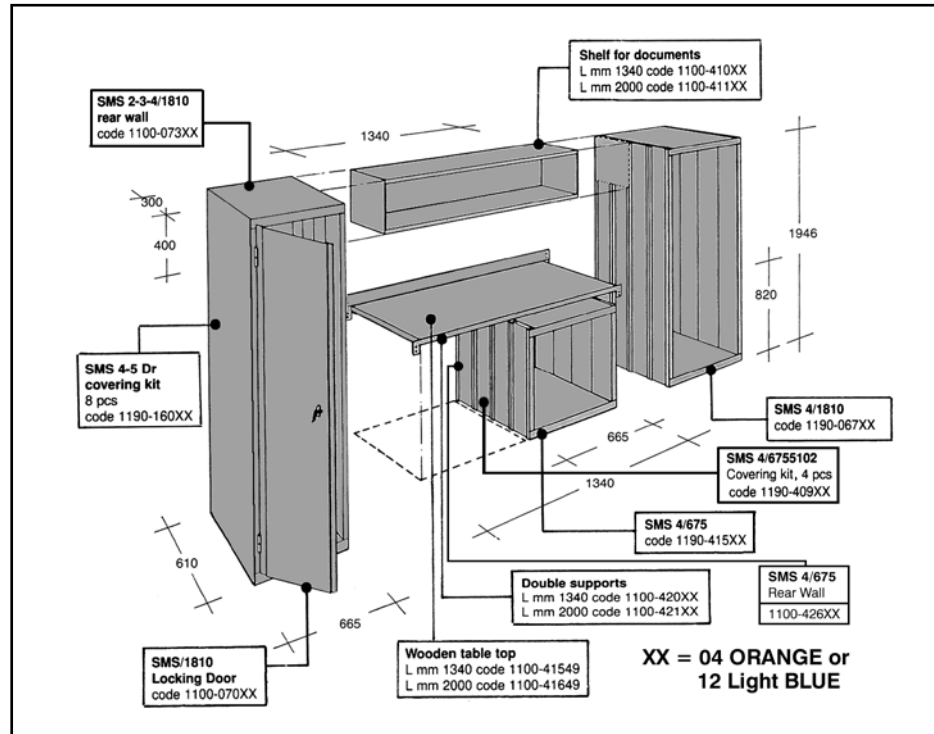

SMS/4 Drawers

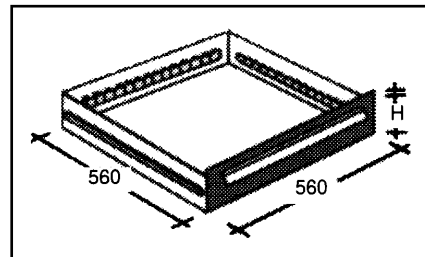

Model	h front	h useful	Capacity kg.	Code
75 T	75	65	125	1100-27001
110 T	110	100	125	1100-27101
150 T	150	140	125	1100-27201
210/150 T	210	200	125	1100-27401
225/150 T	225	215	125	1100-27301
KIT Frame	75	65	125	1100-31401

NB: Every drawer is equipped with locking device.

Sockets



Model	Qty x unit	Code
ISO 30	9	1100-05918
ISO 35	9	1100-06718
ISO 40	8	1100-05118
ISO 45	6	1100-05218
ISO 50	5	1100-05318
ISO Multisize		1100-05518
HSK 40A	11	1100-22118
HSK 50A	6	1100-22318
HSK 63A	6	1100-22418
HSK 80A	6	1100-22518
HSK 100A	5	1100-22618
VDI 30	7	1100-06318
VDI 40	6	1100-06418
VDI 50	5	1100-06518
VDI 60	4	1100-06618

Sockets Available

HSK-A
Kennametal KM

Komet ABS
Sandvik Capto
Toolholders

Storage Cabinets & Trolleys



Ministores

Standard Ministores can be chosen as shown. Letters indicate internal configuration as shown on opposite page. The last two numbers indicate taper of holders.

The Ministore price is inclusive of all internal parts as shown. Each module's price includes all internal components as shown. They can either be specified as an integral part of a new Ministore or added later, as your storage needs grow.

Standard colors in special epoxy polymerized paint are:

- Combiracks - Lobster Red
- Drawers - Slate Gray
- Back/side panels, int. frames - Zinc Plated Steel.

A compact tool wash machine designed to fit under the tabletop is a perfect compliment to the work station. It is completely self contained and is recommended for the proper protection of stored tooling.

Contact your SUSTA Sales Engineer for additional information.

Many years of experience in storage has enabled SUSTA to develop the ultimate storage system for tool rooms, metrology labs, turning and machining centers, inspection and workstations.

Assembly - All Ministores and Combiracks are easily assembled and are delivered in kit form with easy-to-follow instructions. Drawers may be added or repositioned in seconds without nuts and bolts.

		ministore 20 Empty shelving code 1190-18504
	MS20AA40 MS20BC40 MS20BG40 MS20EG40 MS20AA45 MS20BC45 MS20BG45 MS20EG45 MS20AA50 MS20BC50 MS20BG50 MS20EG50	

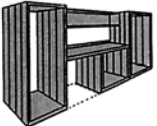
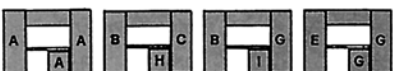
		ministore 21 Empty shelving code 1190-18604
	MS21AAA40 MS21BCH40 MS21BGI40 MS21EGG40 MS21AAA45 MS21BCH45 MS21BGI45 MS21EGG45 MS21AAA50 MS21BCH50 MS21BGI50 MS21EGG50	

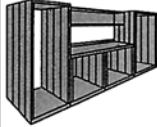
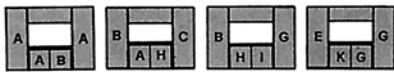
		ministore 22 Empty shelving code 1190-18704
	MS22AAB40 MS22BCAH40 MS22BGI40 MS22EGKG40 MS22AAB45 MS22BCAH45 MS22BGI45 MS22EGKG45 MS22AAB50 MS22BCAH50 MS22BGI50 MS22EGKG50	

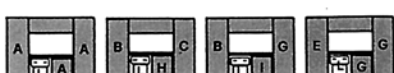
		ministore 21L Empty shelving code 1190-18804
	MS21LAA40 MS21LBC40 MS21LBGI40 MS21LEGG40 MS21LAA45 MS21LBC45 MS21LBGI45 MS21LEGG45 MS21LAA50 MS21LBC50 MS21LBGI50 MS21LEGG50	

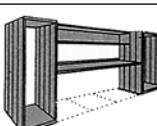
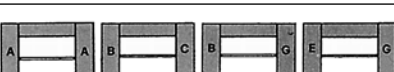
		ministore 30 Empty shelving code 1190-18904
	MS30AA40 MS30BC40 MS30BG40 MS30EG40 MS30AA45 MS30BC45 MS30BG45 MS30EG45 MS30AA50 MS30BC50 MS30BG50 MS30EG50	

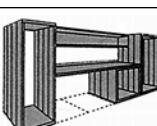
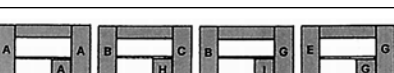
		ministore 31 Empty shelving code 1190-19004
	MS31AAA40 MS31BCH40 MS31BGI40 MS31EGG40 MS31AAA45 MS31BCH45 MS31BGI45 MS31EGG45 MS31AAA50 MS31BCH50 MS31BGI50 MS31EGG50	

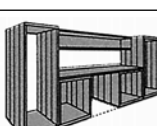
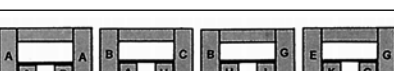
		ministore 32 Empty shelving code 1190-19104
	MS32AAB40 MS32BCAH40 MS32BGI40 MS32EGKG40 MS32AAB45 MS32BCAH45 MS32BGI45 MS32EGKG45 MS32AAB50 MS32BCAH50 MS32BGI50 MS32EGKG50	

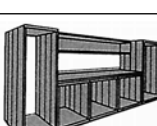
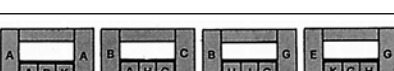
		ministore 33 Empty shelving code 1190-19204
	MS33AABK40 MS33BCAHC40 MS33BGHIG40 MS33EGKG40 MS33AABK45 MS33BCAHC45 MS33BGHIG45 MS33EGKG45 MS33AABK50 MS33BCAHC50 MS33BGHIG50 MS33EGKG50	

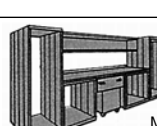
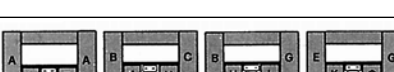
		ministore 32L Empty shelving code 1190-19304
	MS32LAA40 MS32LBCAH40 MS32LBGI40 MS32LEGG40 MS32LAA45 MS32LBCAH45 MS32LBGI45 MS32LEGG45 MS32LAA50 MS32LBCAH50 MS32LBGI50 MS32LEGG50	

Storage Cabinets & Trolleys



SMS 4A
ISO40 64 1190-16104
ISO45 48 1190-16204
ISO50 40 1190-16304

SMS 4B
ISO40 2001190-16404
ISO45 150 1190-16504
ISO50 125 1190-16604
TR28 275 1190-16704
TR36 175 1190-16804

SMS 4C
ISO40 184 1190-16904
ISO45 138 1190-17004
ISO50 115 1190-17104

SMS 4D
CODE 1190-17204

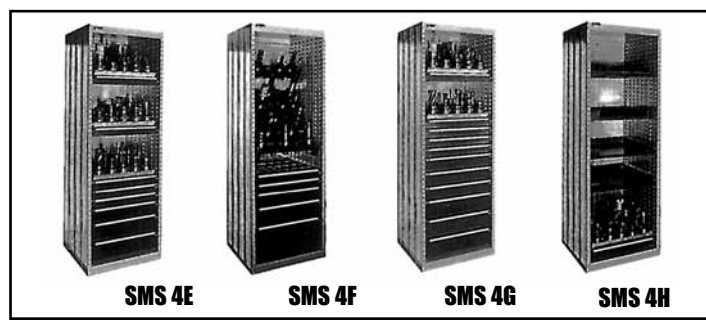

SMS 4E
ISO40 120 1190-17304
ISO45 90 1190-17404
ISO50 75 1190-17504

SMS 4F
ISO40 48 1190-17604
ISO45 36 1190-17704
ISO50 30 1190-17804

SMS 4G
ISO40 80 1190-17904
ISO45 60 1190-18004
ISO50 50 1190-18104

SMS 4H
ISO40 40 1190-18204
ISO45 30 1190-18304
ISO50 25 1190-18404

Ministore

The Ministore system combines the advantages of maximized storage density with a user-oriented workstation in an area as little as 17 square feet of floor space.

Ministores can be custom-tailored to provide the best solution to your storage needs by using the components shown on pages 1-68 and 1-76. Each fully-telescoping frame and drawer has a full length handle with identification label for properly organizing its' contents. In drawers with the 'Kit 5' socket frame, each row is designated to accept the max. number of tools per shelf.

Drawers are provided with internal dividing slots that accept the numerous standard configurations shown on page 6. Drawer dividers must be ordered separately. The number after ISOxx represents the number of sockets supplied.



SMS 4/675 A
CODE 1190-41704

SMS 4/675 B
CODE 1190-41804

SMS 4/675 C
CODE 1190-41904



SMS 4/675 D
CODE 1190-42004

SMS 4/675 E
CODE 1190-42104

SMS 4/675 F
CODE 1190-42204



SMS 4/675 G
CODE 1190-42304

SMS 4/675 H
CODE 1190-42404



SMS 4/675 I
ISO40 120 1190-42504
ISO45 90 1190-42604
ISO50 75 1190-42704
TR28 165 1190-42804

SMS 4/675 K
ISO40 80 1190-42904
ISO45 60 1190-43004
ISO50 50 1190-43104
TR28 110 1190-43204

Storage Cabinets & Trolleys

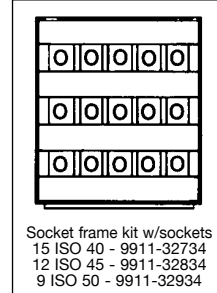
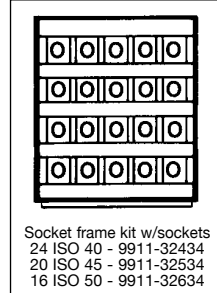
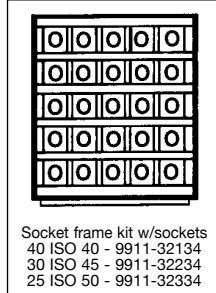
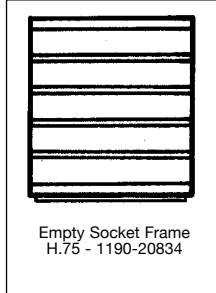
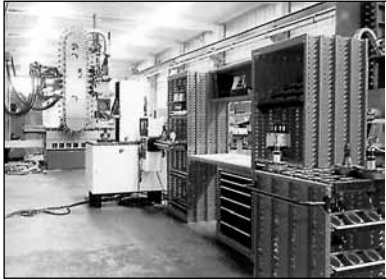

Ministore

Ministore provides efficient storage allowing quick selection to tools. The label holder, incorporated into the handle, provides identification of internally stored tools

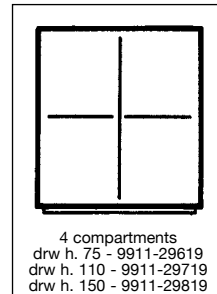
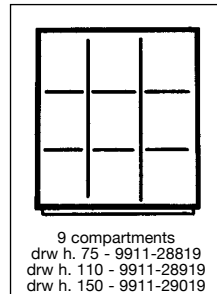
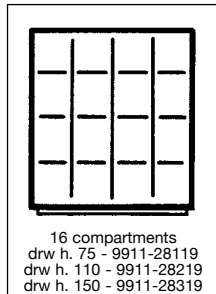
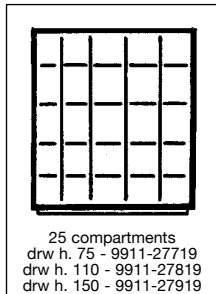

Control

Tool management within the Ministore creates additional time for other work. The Ministore permits better control of tools and each drawer has 100% extension of opening which allows the operator to have a complete view of all stored components. This eliminates tool loss, understocking, and duplication.

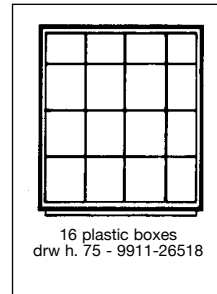
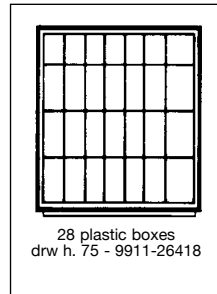
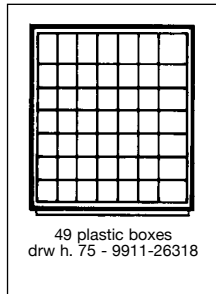
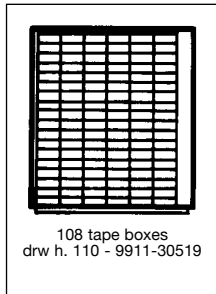

Productivity

Due to the fact that the Ministore can be located next to the machine, the retrieval time is reduced which increases productivity.

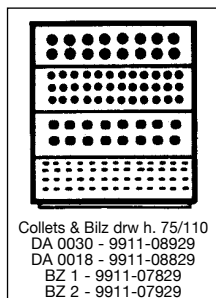
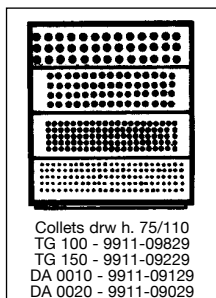
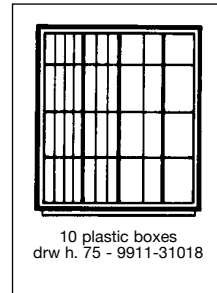
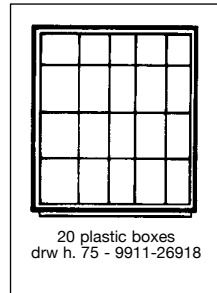
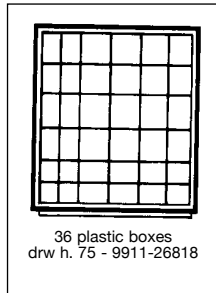
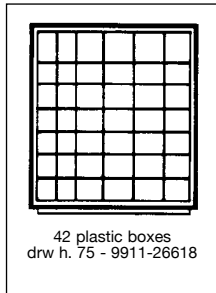

Drawers can be divided internally with standard dividers in various combinations. All components are standard stock items and identified as a complete set for easier selection. Complete sets are shown, each with its' own code number.

Storage Cabinets & Trolleys



Ministore

The Ministore modules can be utilized as individual work benches which can be selected either from standard configurations, as shown, or customized to suit customer needs. By incorporating the Ministore with standard SMS Tool Carts, almost all possible storage problems can be solved

The Ministore provides the ideal 'start-up' storage system which can be expanded as needs increase, making it the most flexible, dense and efficient storage system available

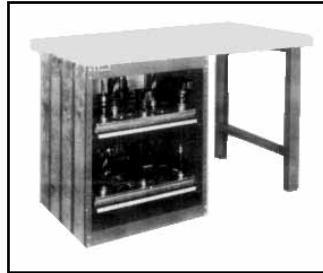

Assembly station STM1

Dim. 1500 x 600 x 875

Empty Shelving code 1190-19504

A	B	C	F
STM1A09CASS	STM1B05CASS	STM1C06CASS	STM1F05CASS
G	H	K	I
STM1G07CASS	STM1H06CASS	STM1KISO40 STM1KISO45 STM1KISO50	STM1IISO40 STM1IISO45 STM1IISO50



Assembly station STM2

Empty Shelving code 1190-19604

Dim. 1500 x 600 x 875

A	B	A	C	F	G	G	H
STM2AB09CAS	STM2AC15CAS	STM2FG12CAS	STM2GH11CAS				
A	I	G	I	G	K	H	I
STM2AIISO40 STM2AIISO45 STM2AIISO50	STM2GIISO40 STM2GIISO45 STM2GIISO50	STM2GKISO40 STM2GKISO45 STM2GKISO50	STM2HIISO40 STM2HIISO45 STM2HIISO50				



Assembly station STM3

Empty Shelving code 1190-19704

Dim. 2000 x 600 x 875

A	B	A	C	F	G
STM3AB09CAS	STM3AC15CAS	STM3FG12CAS			
A	I	G	I	G	K
STM3AIISO40 STM3AIISO45 STM3AIISO50	STM3GIISO40 STM3GIISO45 STM3GIISO50	STM3GKISO40 STM3GKISO45 STM3GKISO50	STM3HIISO40 STM3HIISO45 STM3HIISO50		
G	H	H	I		
STM3GH11CAS					

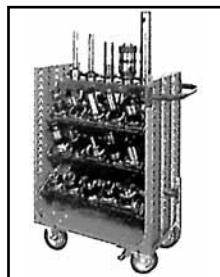

SMS3 Trolley

7 units, SIV and sockets for:

56 ISO40 code 1190-02104
42 ISO45 code 1190-02204
35 ISO50 code 1190-02304

Dim. 790 x 460 x 970



SMS4 Trolley

10 units, SIV and sockets for:

80 ISO40 code 1190-02404
60 ISO45 code 1190-02504
50 ISO50 code 1190-02604

Dim. 790 x 616 x 979



SMS5 Trolley

13 units, SIV and sockets for:

104 ISO40 code 1190-02704
78 ISO45 code 1190-02804
65 ISO50 code 1190-02904

Dim. 948 x 675 x 1016

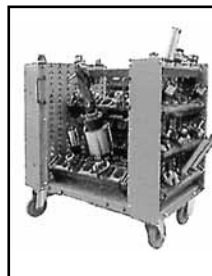

SMS6 Trolley

16 units, SIV and sockets for:

128 ISO40 code 1190-03004
96 ISO45 code 1190-03104
80 ISO50 code 1190-03204

Dim. 981 x 950 x 1016

Tool Trolleys & Accessories

Tool Trolleys



1190-009xx SMS 3 tool trolley holds seven tool trays. Comes with four 6" casters and end handle. Assembly required. 31"L x 18" W x 39" H. Wt. Cap. 1000 lbs.



1190-004xx SMS 4 tool trolley moves tools to the job. Add brackets and up to ten tool trays to hold tools. Comes with four 6" casters and end handle. Assembly req'd. 31"L x 24" W x 40" H. Wt. Cap. 2200 lbs.

Accessories

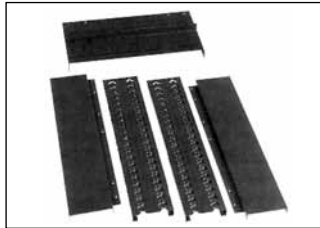

1100-107xx kit comes with additional panels and hardware to turn basic model 1190-004xx into SMS 5 tool trolley. Two 1100-107xx kits turn model SMS 4 into SMS 6. Holds three trays or one row of arbor holders. 26.5" W x 6" D x 32.5" H.



Steel shelf provides additional work space. Comes with rubber mat. Shelf No. 1100-005xx fits on trolley 1190-009xx. 18" W x 12" D x 1.5" H. Shelf No. 1100-004xx fits trolley 1190-004xx. 24" W x 12" D x 1.5" H.

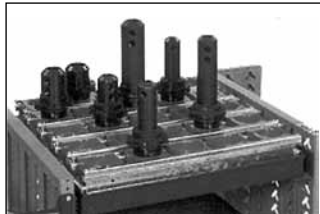

1100-63701 fixed frame requires adjustable tool holder kit 76208. Holds up to five rows of tools. Fits trolley 1190-004xx



Shelves for trolleys have ribbed rubber mats, 3/4" high shelf edge. Brackets attach to inside trolley walls. Wt. Cap. 200 lbs.

Model 1100-00801
23.75" W x 22.6" D x 1.75" H
Model 1100-00901
23.75" W x 16.5" D x 1.75" H
Model 1100-01001
23.75" W x 10.25" D x 1.75" H

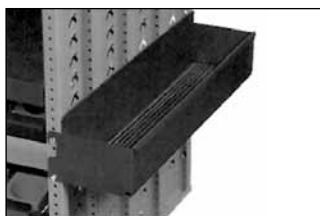

1100-02001 carryall box holds lubricant cans, tools and supplies. Bolts to end of trolley 1190-004xx

xx = 04 LOBSTER ORANGE
12 LIGHT BLUE